

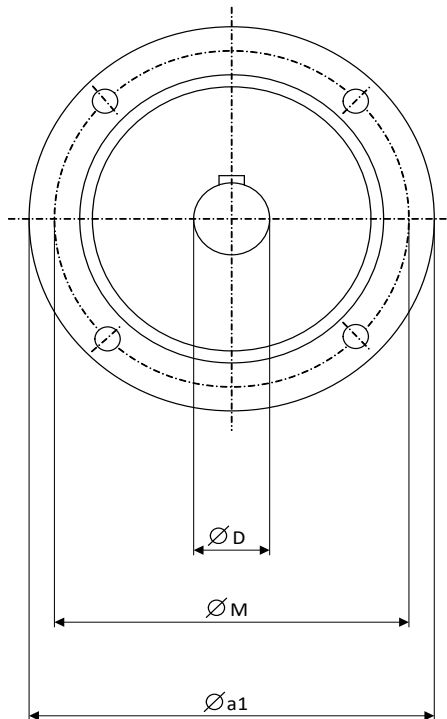

Fixing dimensions according to IEC EN 50347

Frame size	Flange outside diameter	Hole circle diameter	Shaft dimensions \varnothing
	a1	M	D
56	A 120	FF 100	9
63	A 140	FF 115	11
71	A 160	FF 130	14
90	A 200	FF 165	24
100	A 250	FF 215	28
112	A 250	FF 215	28
132	A 300	FF 265	38
160	A 350	FF 300	42
180	A 350	FF 300	48
200	A 400	FF 350	55
225	A 450	FF 400	55
250	A 550	FF 500	65
280	A 550	FF 500	75
315	A 660	FF 600	80
<hr/>			
56	C 80	FT 65	9
63	C 90	FT 75	11
71	C 105	FT 85	14
80	C 120	FT 100	19
90	C 140	FT 115	24
100	C 160	FT 130	28
112	C 160	FT 130	28
132	C 200	FT 165	38



The exact dimensions of the motor can be extracted from the dimension sheets.

Different dimensions and layouts are possible on request.

Stand 09.04.2024